



DAS MODULARE WERBESYSTEM

AUFBAUANLEITUNG

PROMO 1*

PROMO 1[®]

Wussten Sie, dass es das einzige
Werbesystem ist, das Sie wirklich brauchen?

Wir möchten uns bei Ihnen für den Kauf von Promo 1[®] bedanken.
Wir hoffen, dass unser Produkt all Ihren Erwartungen entsprechen
wird und für schnelle und effektive Werbemaßnahmen sorgt.

Auf den nächsten Seiten der vorliegenden Broschüre finden Sie
fertige Stand-Konzepte, die man aus Promo 1[®] aufbauen kann.
Falls Sie eventuelle Fragen oder Zweifel haben, hilft Ihnen die
Webseite www.promo-1.net. Sie können sich auch jeder Zeit mit
unseren Vertretern in Verbindung setzen.

Wir wünschen Ihnen viel Erfolg!
Ihr Promo1-Team



WIE SCHNELL UND LEICHT LÄSST SICH EIN PROMO 1®-STAND AUFBAUEN?

Dank einer werkzeuglosen Montage und magnetischen Grafikpaneelen können Sie jedes Set blitzschnell aufbauen.

01— MOBILER UND BEQUEMER TRANSPORT

Promo 1® ist ein System leichter, solider Aluminiumrahmen, die Sie auf einem bequemen Transportkarren- / Trolley und in einem Kombi problemlos transportieren können.

02— INTUITIVE MONTAGE OHNE ANWENDUNG VON WERKZEUGEN

Die Rahmen des Promo1®-Systems lassen sich werkzeuglos, mithilfe besonderer Connectoren verbinden. Diverses Zubehör steht Ihnen zur Verfügung.

03— AUSTAUSCHBARE GRAFIK-PANEELE

Dank austauschbarer, magnetisch angebrachter Grafik-Paneele können Sie nach Bedarf blitzschnell und mühelos die Optik des Promo1®-Standes verändern.



KONFIGURATIONEN ÜBERBLICK



— 01



— 02



— 03



— 04



— 05



— 06



— 07



— 08



— 09



— 10



— 11



— 12



— 13



— 14



— 15



— 16



— 17



— 18



— 19



— 20



— 21



— 22



— 23



— 24

KONFIGURATION — 01

TECHNISCHE INFORMATION

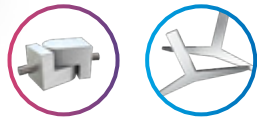
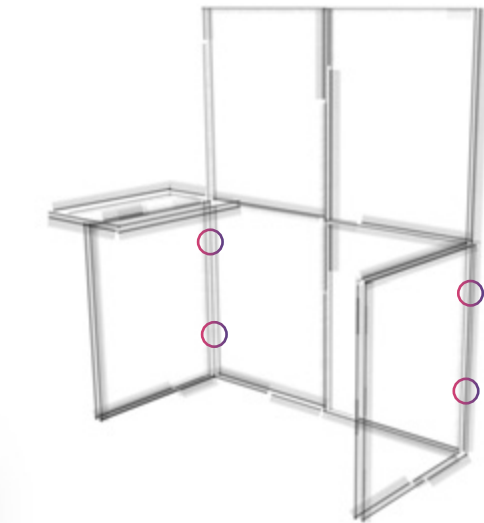

EIGENSCHAFTEN DES PROMO 1



Kinderleichte
1-Mann-Montage



Möglichkeit einer
mehrfachen
Anwendung



Schnelle Montage
in nur 15 Minuten



Das Set passt
in ein Pkw



Werkzeuglose
Montage

GRUNDRISS DES STANDES

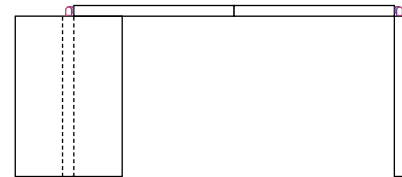

KONFIGURATION — 02

TECHNISCHE INFORMATION

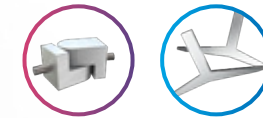
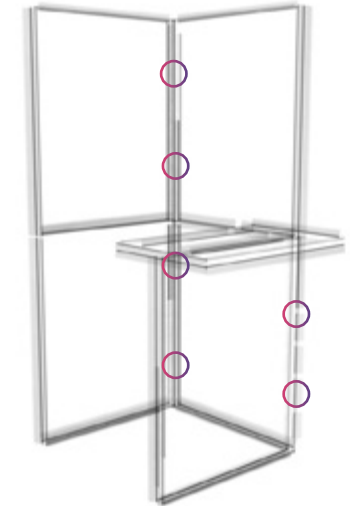

EIGENSCHAFTEN DES PROMO 1



Kinderleichte
1-Mann-Montage



Möglichkeit einer
mehrfachen
Anwendung



Schnelle Montage
in nur 15 Minuten



Das Set passt
in ein Pkw



Werkzeuglose
Montage

GRUNDRISS DES STANDES

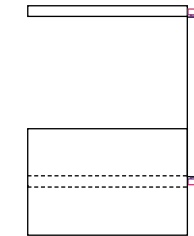

KONFIGURATION — 03

TECHNISCHE INFORMATION

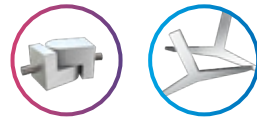
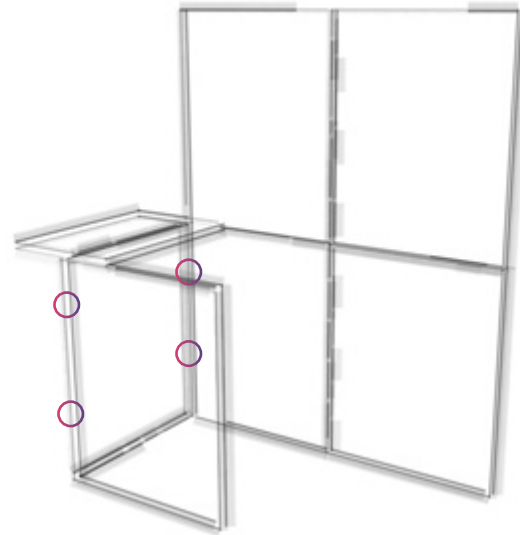

EIGENSCHAFTEN DES PROMO 1

- Kinderleichte 1-Mann-Montage
- Möglichkeit einer mehrfachen Anwendung
- Schnelle Montage in nur 15 Minuten
- Das Set passt in ein Pkw
- Werkzeuglose Montage

GRUNDRISS DES STANDES

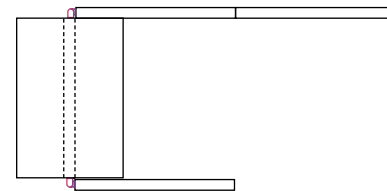

KONFIGURATION — 04

TECHNISCHE INFORMATION

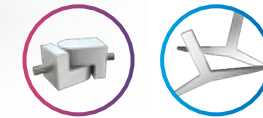
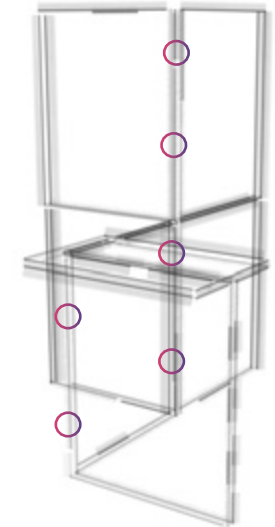

EIGENSCHAFTEN DES PROMO 1

- Kinderleichte 1-Mann-Montage
- Möglichkeit einer mehrfachen Anwendung
- Schnelle Montage in nur 15 Minuten
- Das Set passt in ein Pkw
- Werkzeuglose

GRUNDRISS DES STANDES

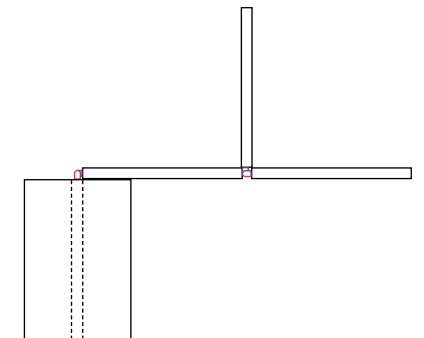



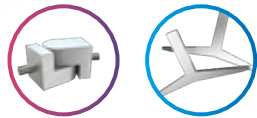
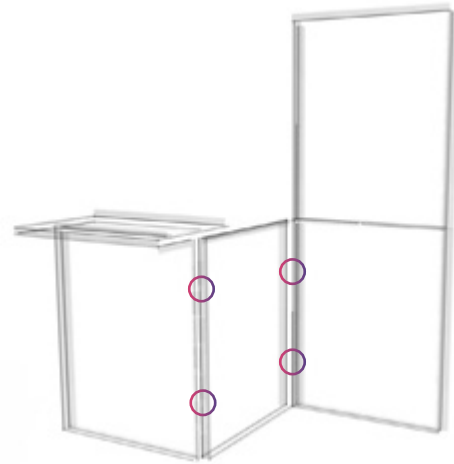

KONFIGURATION — 05

TECHNISCHE INFORMATION



EIGENSCHAFTEN DES PROMO 1

-  Kinderleichte 1-Mann-Montage
-  Möglichkeit einer mehrfachen Anwendung
-  Schnelle Montage in nur 15 Minuten
-  Das Set passt in ein Pkw
-  Werkzeuglose Montage

GRUNDRISS DES STANDES

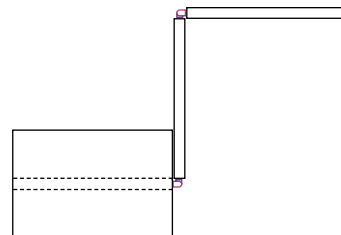



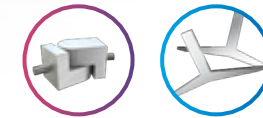
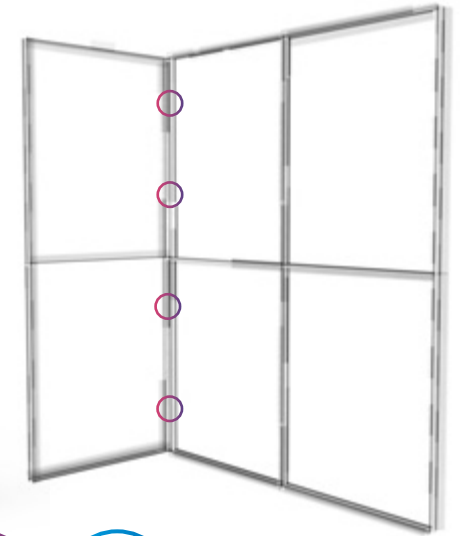

KONFIGURATION — 06

TECHNISCHE INFORMATION



EIGENSCHAFTEN DES PROMO 1

-  Kinderleichte 1-Mann-Montage
-  Möglichkeit einer mehrfachen Anwendung
-  Schnelle Montage in nur 15 Minuten
-  Das Set passt in ein Pkw
-  Werkzeuglose

GRUNDRISS DES STANDES

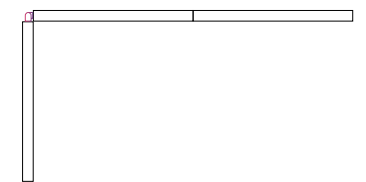

KONFIGURATION — 07

TECHNISCHE INFORMATION

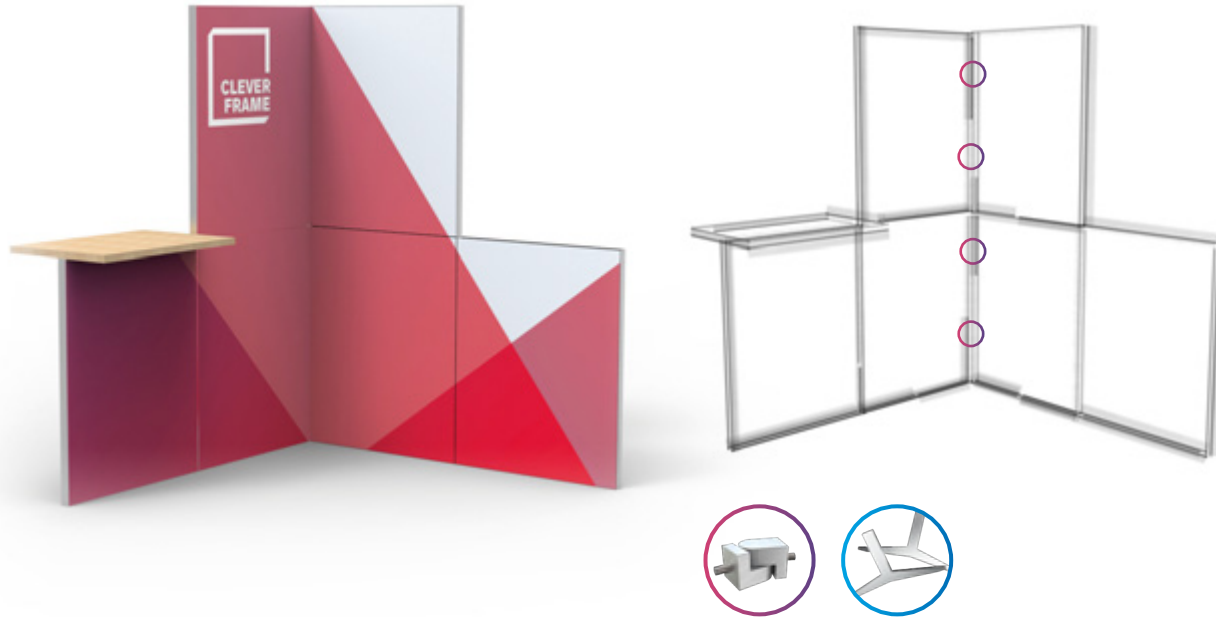

EIGENSCHAFTEN DES PROMO 1

- Kinderleichte 1-Mann-Montage
- Möglichkeit einer mehrfachen Anwendung
- Schnelle Montage in nur 15 Minuten
- Das Set passt in ein Pkw
- Werkzeuglose Montage

GRUNDRISS DES STANDES

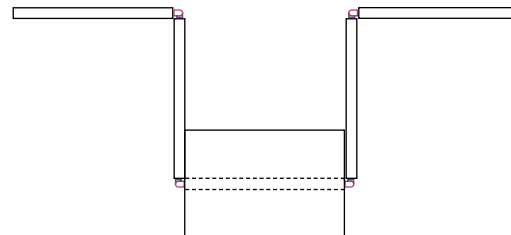

KONFIGURATION — 08

TECHNISCHE INFORMATION



EIGENSCHAFTEN DES PROMO 1

- Kinderleichte 1-Mann-Montage
- Möglichkeit einer mehrfachen Anwendung
- Schnelle Montage in nur 15 Minuten
- Das Set passt in ein Pkw
- Werkzeuglose

GRUNDRISS DES STANDES

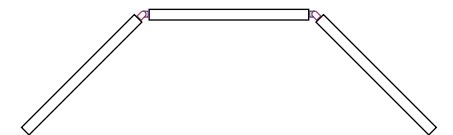

KONFIGURATION — 09

TECHNISCHE INFORMATION

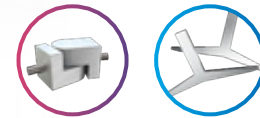
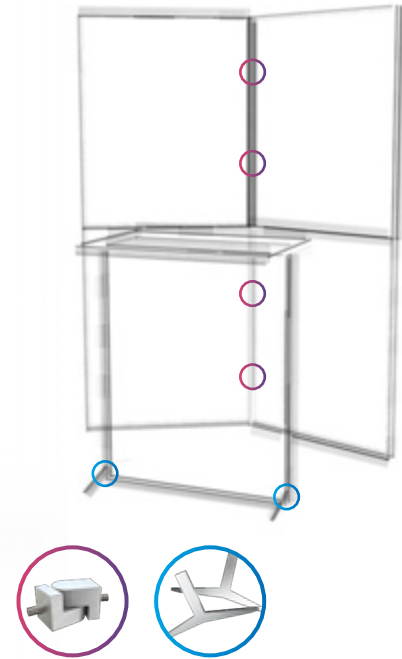

EIGENSCHAFTEN DES PROMO 1



Kinderleichte
1-Mann-Montage



Möglichkeit einer
mehrfachen
Anwendung



Schnelle Montage
in nur 15 Minuten



Das Set passt
in ein Pkw



Werkzeuglose
Montage

GRUNDRISS DES STANDES

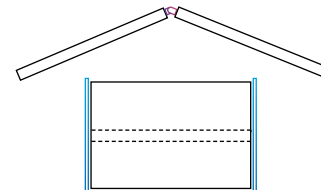

KONFIGURATION — 10

TECHNISCHE INFORMATION

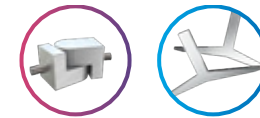
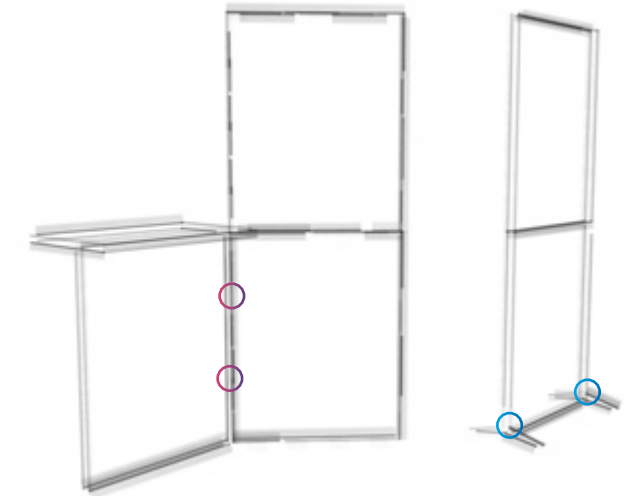

EIGENSCHAFTEN DES PROMO 1



Kinderleichte
1-Mann-Montage



Möglichkeit einer
mehrfachen
Anwendung



Schnelle Montage
in nur 15 Minuten



Das Set passt
in ein Pkw



Werkzeuglose
Montage

GRUNDRISS DES STANDES

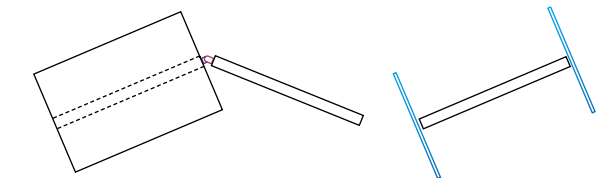

KONFIGURATION — 11

TECHNISCHE INFORMATION

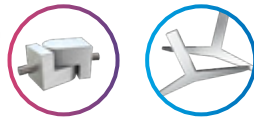
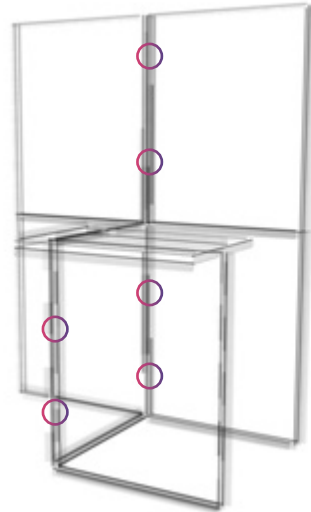

EIGENSCHAFTEN DES PROMO 1



Kinderleichte
1-Mann-Montage



Möglichkeit einer
mehrfachen
Anwendung



Schnelle Montage
in nur 15 Minuten



Das Set passt
in ein Pkw



Werkzeuglose
Montage

GRUNDRISS DES STANDES

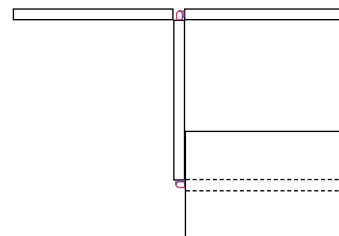

KONFIGURATION — 12

TECHNISCHE INFORMATION

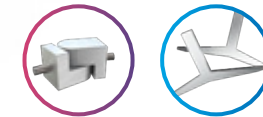
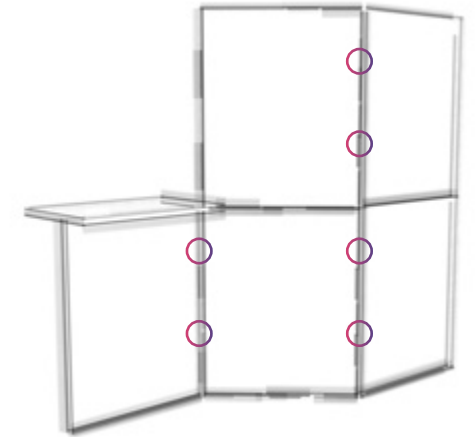

EIGENSCHAFTEN DES PROMO 1



Kinderleichte
1-Mann-Montage



Möglichkeit einer
mehrfachen
Anwendung



Schnelle Montage
in nur 15 Minuten



Das Set passt
in ein Pkw



Werkzeuglose
Montage

GRUNDRISS DES STANDES

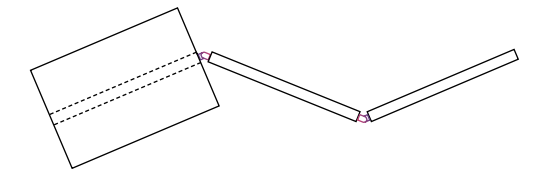

KONFIGURATION — 13

TECHNISCHE INFORMATION

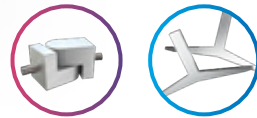
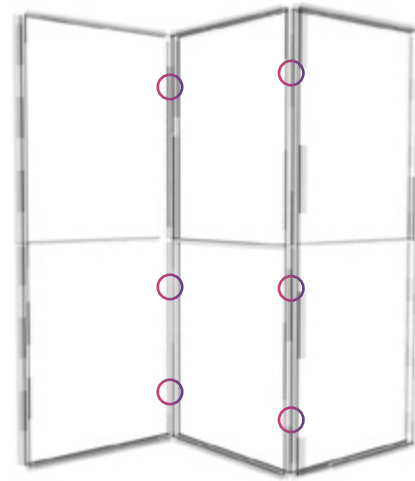

EIGENSCHAFTEN DES PROMO 1



Kinderleichte
1-Mann-Montage



Möglichkeit einer
mehrfachen
Anwendung



Schnelle Montage
in nur 15 Minuten



Das Set passt
in ein Pkw



Werkzeuglose
Montage

GRUNDRISS DES STANDES

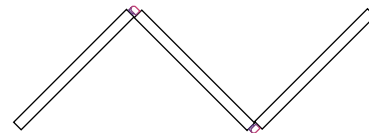

KONFIGURATION — 14

TECHNISCHE INFORMATION

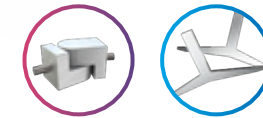
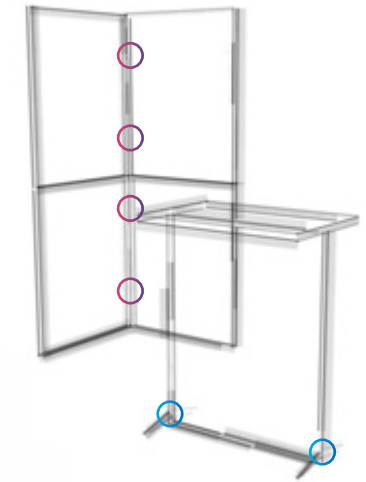

EIGENSCHAFTEN DES PROMO 1



Kinderleichte
1-Mann-Montage



Möglichkeit einer
mehrfachen
Anwendung



Schnelle Montage
in nur 15 Minuten



Das Set passt
in ein Pkw



Werkzeuglose
Montage

GRUNDRISS DES STANDES

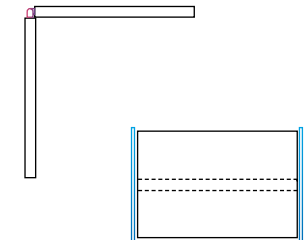

KONFIGURATION — 15



TECHNISCHE INFORMATION

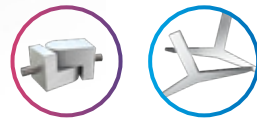
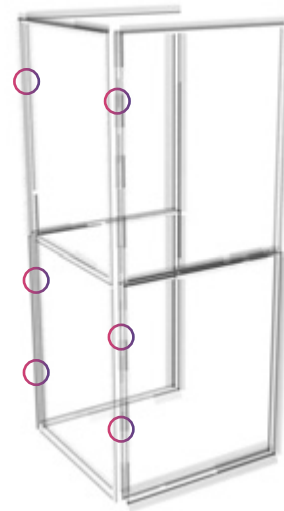

EIGENSCHAFTEN DES PROMO 1



Kinderleichte
1-Mann-Montage



Möglichkeit einer
mehrfachen
Anwendung



Schnelle Montage
in nur 15 Minuten



Das Set passt
in ein Pkw



Werkzeuglose
Montage

GRUNDRISS DES STANDES

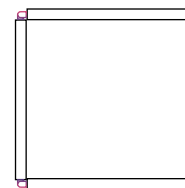

KONFIGURATION — 16



TECHNISCHE INFORMATION



EIGENSCHAFTEN DES PROMO 1



Kinderleichte
1-Mann-Montage



Möglichkeit einer
mehrfachen
Anwendung



Schnelle Montage
in nur 15 Minuten



Das Set passt
in ein Pkw



Werkzeuglose
Montage

GRUNDRISS DES STANDES



KONFIGURATION — 17



TECHNISCHE INFORMATION

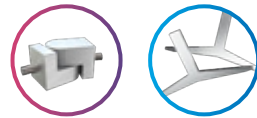

EIGENSCHAFTEN DES PROMO 1



Kinderleichte
1-Mann-Montage



Möglichkeit einer
mehrfachen
Anwendung



Schnelle Montage
in nur 15 Minuten



Das Set passt
in ein Pkw



Werkzeuglose
Montage

GRUNDRISS DES STANDES



KONFIGURATION — 18



TECHNISCHE INFORMATION

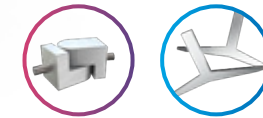
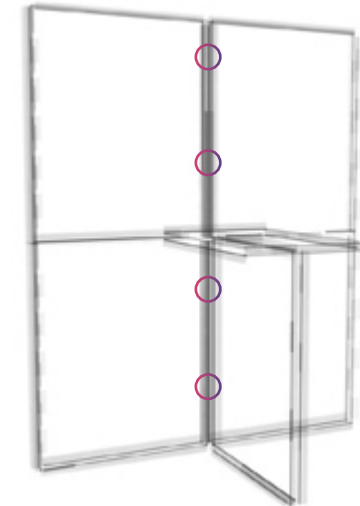

EIGENSCHAFTEN DES PROMO 1



Kinderleichte
1-Mann-Montage



Möglichkeit einer
mehrfachen
Anwendung



Schnelle Montage
in nur 15 Minuten



Das Set passt
in ein Pkw



Werkzeuglose
Montage

GRUNDRISS DES STANDES

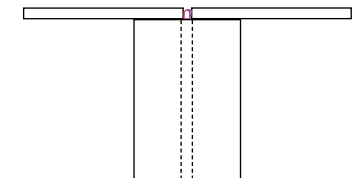

KONFIGURATION — 19

KONFIGURATION — 20



TECHNISCHE INFORMATION

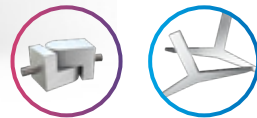
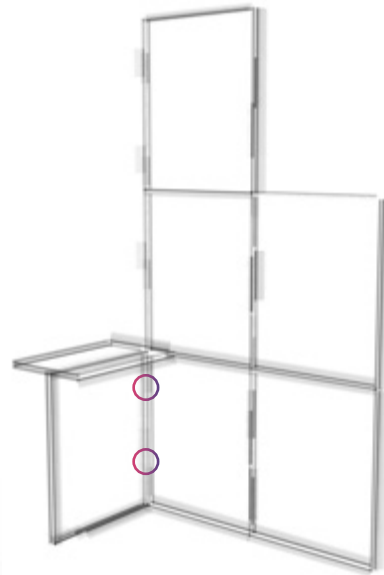

EIGENSCHAFTEN DES PROMO 1



Kinderleichte
1-Mann-Montage



Möglichkeit einer
mehrfachen
Anwendung



Schnelle Montage
in nur 15 Minuten



Das Set passt
in ein Pkw



Werkzeuglose
Montage

GRUNDRISS DES STANDES

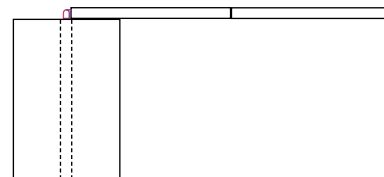

TECHNISCHE INFORMATION

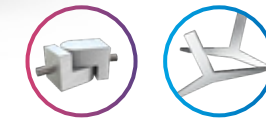
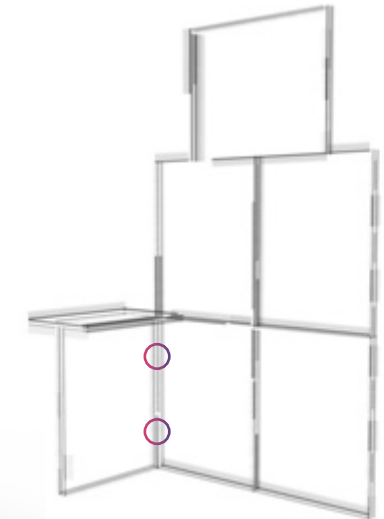

EIGENSCHAFTEN DES PROMO 1



Kinderleichte
1-Mann-Montage



Möglichkeit einer
mehrfachen
Anwendung



Schnelle Montage
in nur 15 Minuten



Das Set passt
in ein Pkw



Werkzeuglose
Montage

GRUNDRISS DES STANDES

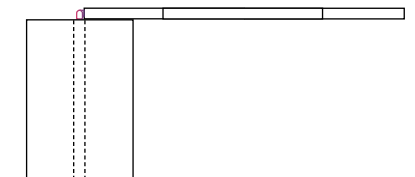

KONFIGURATION — 21

KONFIGURATION — 22

TECHNISCHE INFORMATION

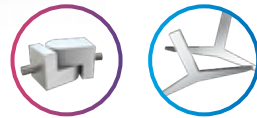
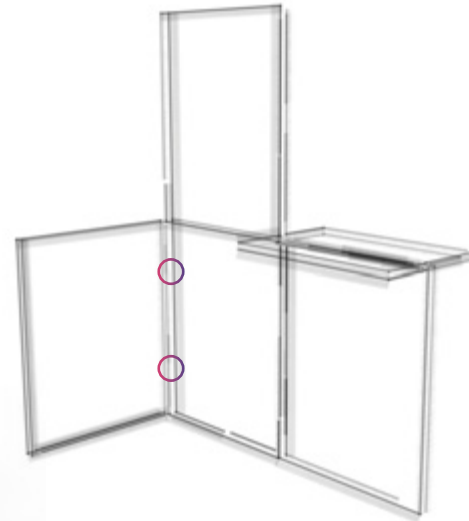

EIGENSCHAFTEN DES PROMO 1



Kinderleichte
1-Mann-Montage



Möglichkeit einer
mehrfachen
Anwendung



Schnelle Montage
in nur 15 Minuten



Das Set passt
in ein Pkw



Werkzeuglose
Montage

GRUNDRISS DES STANDES

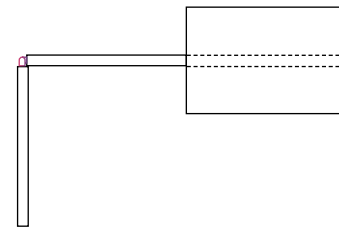

TECHNISCHE INFORMATION

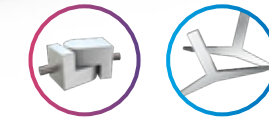
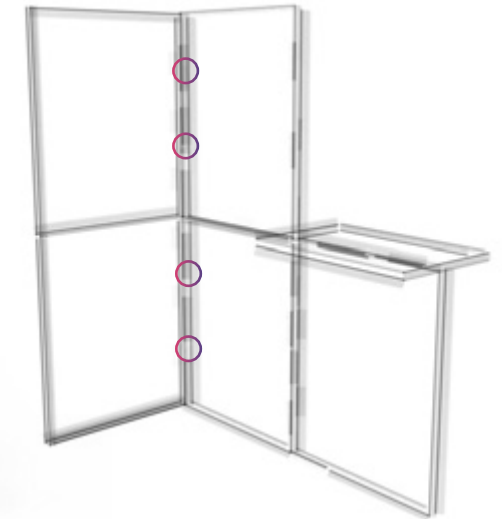

EIGENSCHAFTEN DES PROMO 1



Kinderleichte
1-Mann-Montage



Möglichkeit einer
mehrfachen
Anwendung



Schnelle Montage
in nur 15 Minuten



Das Set passt
in ein Pkw



Werkzeuglose
Montage

GRUNDRISS DES STANDES

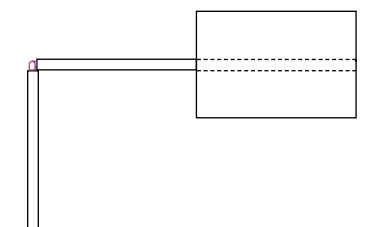

KONFIGURATION — 23

TECHNISCHE INFORMATION

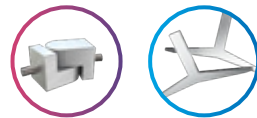

EIGENSCHAFTEN DES PROMO 1

- Kinderleichte 1-Mann-Montage
- Möglichkeit einer mehrfachen Anwendung
- Schnelle Montage in nur 15 Minuten
- Das Set passt in ein Pkw
- Werkzeuglose Montage

GRUNDRISS DES STANDES

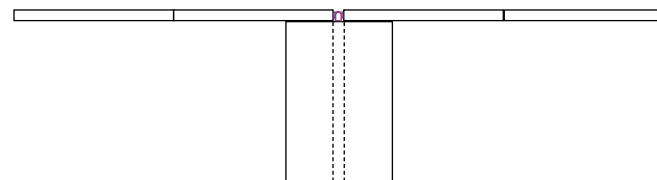

KONFIGURATION — 24

TECHNISCHE INFORMATION



EIGENSCHAFTEN DES PROMO 1

- Kinderleichte 1-Mann-Montage
- Möglichkeit einer mehrfachen Anwendung
- Schnelle Montage in nur 15 Minuten
- Das Set passt in ein Pkw
- Werkzeuglose

GRUNDRISS DES STANDES

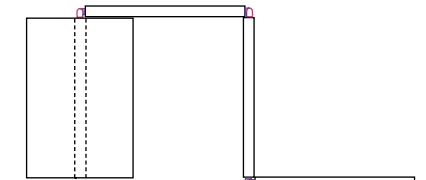

PROMO 1[®]

5 Jahre Garantie

auf die Bau-Elemente und 12 Monate auf Grafik-Paneele.

Clever Frame International Sp. z o.o.

office@cleverframe.com

www.cleverframe.de

Clever Frame[®] ist ein eingetragenes Warenzeichen.
Kopieren des Systems und der Teile ist verboten
© 2010 Clever Frame International. All rights reserved



Besuchen Sie www.promo-1.net